

apostolidaniele

Q

Apostoli Daniele deals with conception and realization of industrial closures and covers, with the purpose to protect the structures in which they are installed, optimizing the performances of light, air, heat and comfort. Since 1959, Apostoli Daniele has been offering to customers a wide selection of products in order to complete private, public and industrial spaces. Born with the production of venetian blinds, today it also offers a wide choice of curtains and home coordinates, technical blinds, awnings and sectional garage doors.

/In Montirone plant, production processes are developed according to rigorous standards that allow to achieve very high-quality results, customised on clients' requests, who receive made-to-measure products, with a very high technological content and controlled with the utmost precision.



What is Saildoor[®]

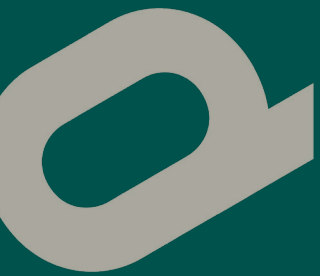

Saildoor® is a new concept of industrial closure, unique in its kind for attitude and performance.

/ A high-speed fold-up door conceived, designed and built to measure for the closure of big industrial openings. Wind resistance, reliability and maintenance ease characterize Saildoor® as a unique product in the world scene.

Saildoor® closure boasts the highest class of wind resistance, that is class 5 of the UNI EN 12424 standard, and it has been certified according to UNI EN 12444 Ch. 7.1, which certifies the resistance of the whole structure. The materials with which it is made tolerate temperature changes and atmospheric agents, making Saildoor® suitable for the most difficult contexts. The particular structure allows a simple and quick maintenance thanks to the placement on the ground of the mechanical components.

Saildoor® ranks among the most sensitive solutions to the environmental impact. This is made possible by low energy consumption and with a high opening / closing speed guaranteeing significant savings in terms of air conditioning.

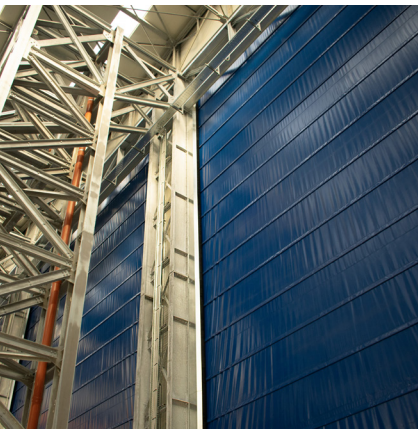
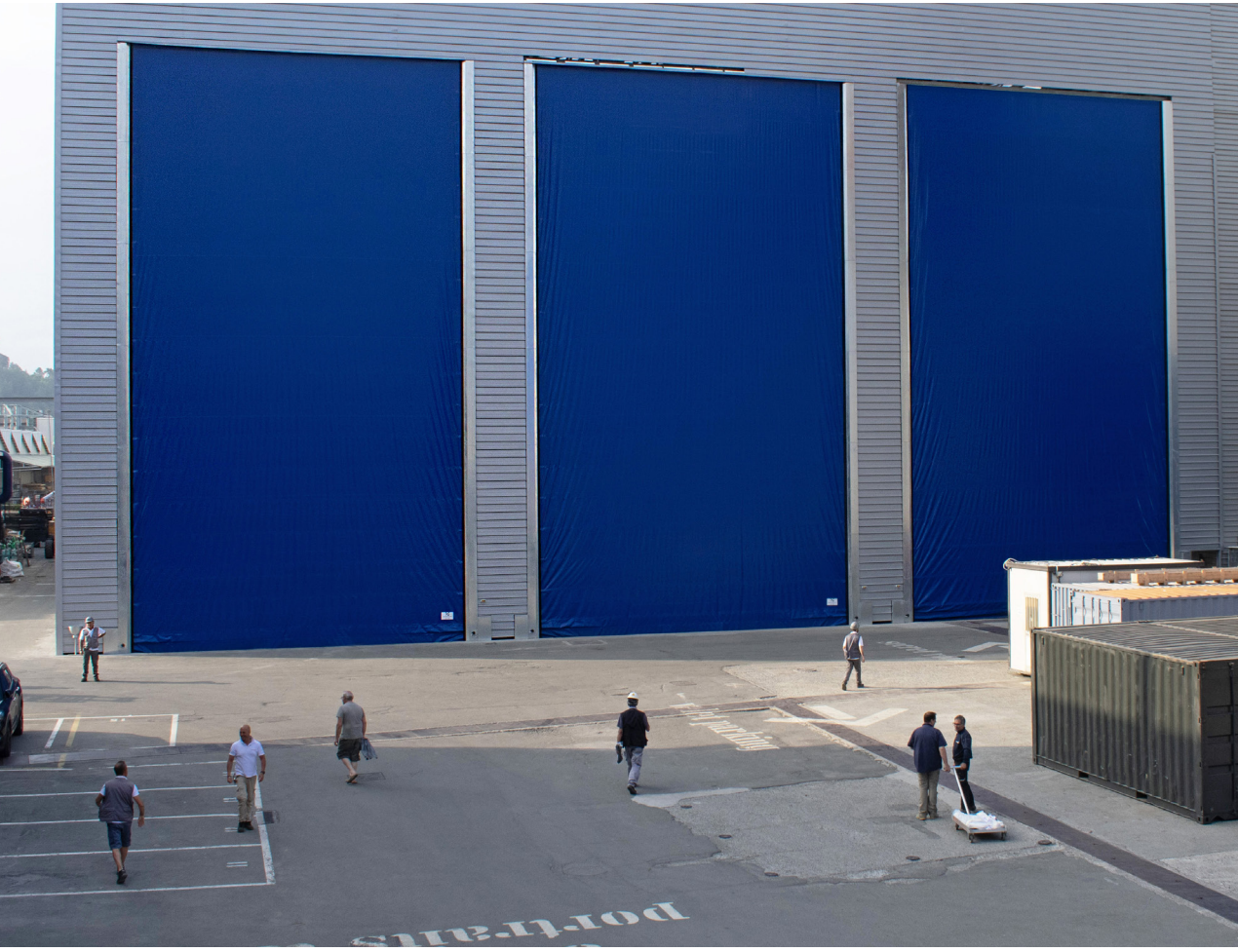

Technical specifications /

Installation

Inside/outside

Pillars

Shaped galvanised steel beams on which slide-patented rollers/bogie.

Covering case in press-curved plate in galvanised steel, RAL on demand.

Crossbeam

Not mechanised with the only purpose of supporting the cloth.

Motors

Two independent motors placed on the floor to facilitate the maintenance, each one positioned beside the pillar

Features

- very high wind resistance – class 5 of the UNI EN 12424 Norm
- high opening /closing speed
- easy maintenance with ground operations
- resistance to thermal jumps and atmospheric agents
- small overall dimensions
- small shipment volumes
- rapid installation
- manual operation in case of black-out
- patented system

Curtain

Self-extinguished PVC class II, 670 gr/sq. m or 900gr/sq. m, stiffened with steel cables joined to the pillars through patented rollers/bogies.

Windows

Windows or visibility stripes

Optional /

Pneumatic or oleo-dynamic for ATEX zones
Soundproofing cloth
REVERSO system
Anti-intrusion cloth
Automatic opening

Technical details /

Opening/closing speed: 0,4 m/s
Resistance to curtain tears: 3000 N/5cm
Doors according UNI EN 13241 standard
Resistance to pressure difference Class 5 according to EN 12424 standard
Tested according UNI EN 12444 CH. 7.1: complete door test

Power supply /

Nominal installation tension: 400V / 3+T
Frequency: 50 Hz
Motor power proportioned to the door dimension
Gear motors placed on the floor

Security Systems /

The patented mechanical fall arrest system avoids the cloth fall in case the transmission chain breaks (T) through intervention of the security chain (S).

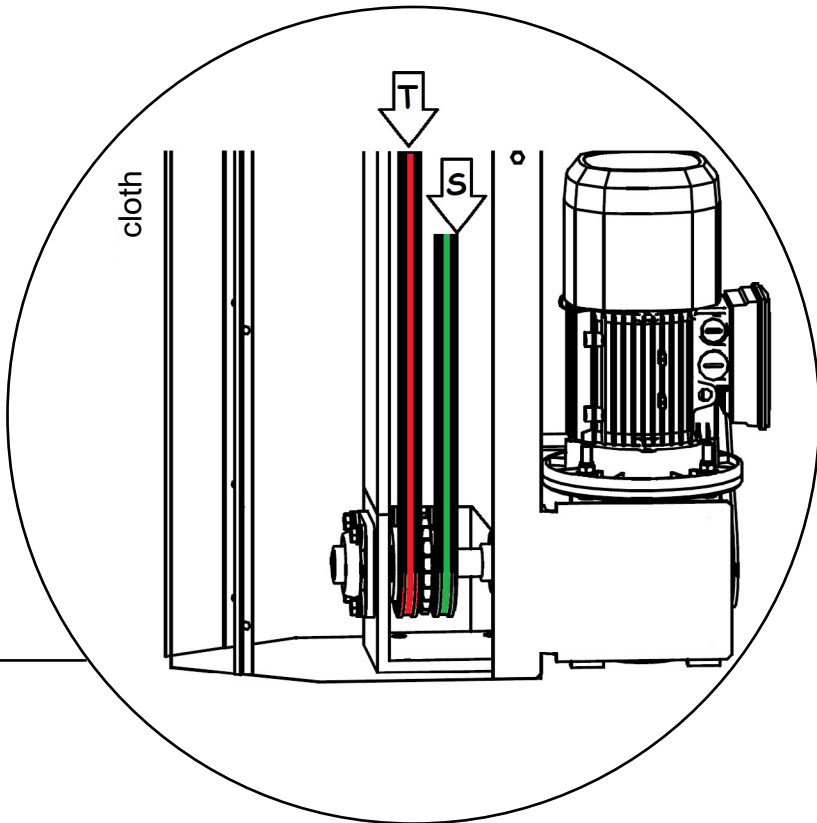
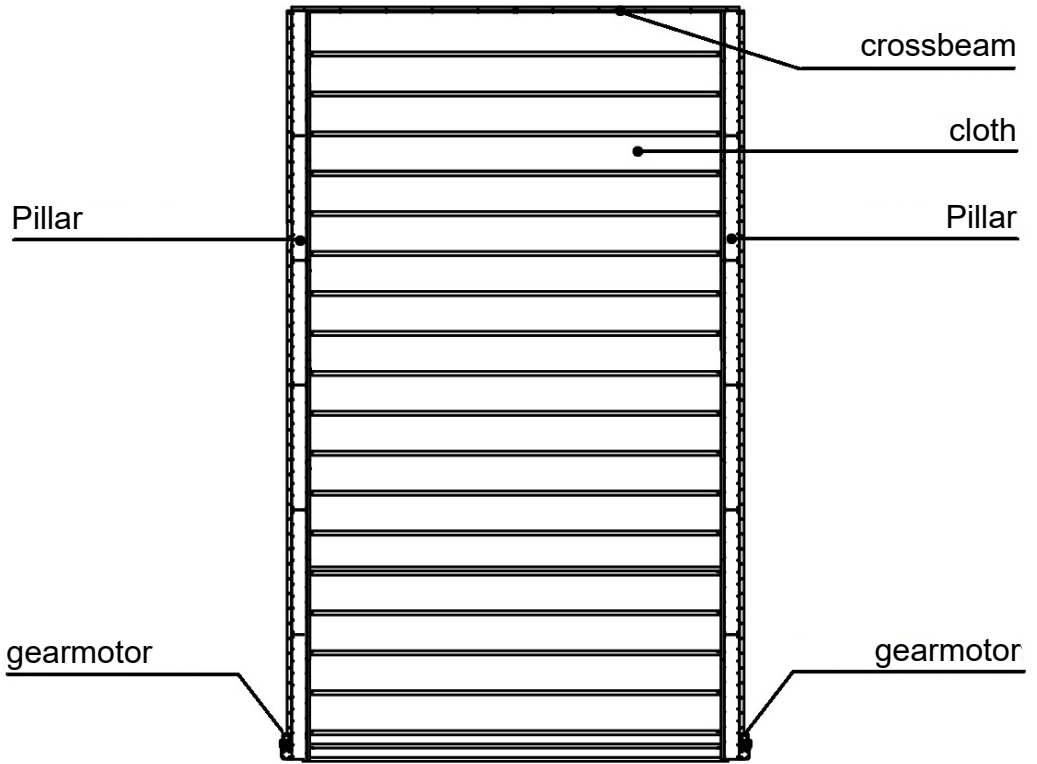

Field of application

nautical



aerospace



industrial



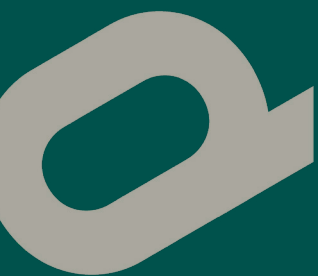

Follow us on
apostoli.it

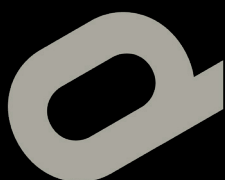

apostolidaniele

Registered office/

Viale Duca degli Abruzzi 167
25124 Brescia, Italy

**Corporate Headquarters and
Manufacturing Facilities/**

Via Palazzo SNC
25010 Montirone (Bs), Italy

Ph. / Fax

+39 030 2170484
+39 030 2170482

apostoli.it
clienti@apostoli.it